

BIANCO NXT tanks

BIANCO NXT BPT Pressure Tanks



WaterMark
WMTS485:2018
WM-032349

Introduction

The primary purpose of a pressure tank is to reduce the number of times the pump needs to start.

A pressure tank reduces noise and needless power consumption, saving energy (and therefore money) while extending the life expectancy of the pump.

By storing a volume of water against a gas 'spring', a supply of pressurized water is available to satisfy small draws offs.

Essential in systems controlled by pressure i.e. by pressure switch, a pressure tank will significantly improve the system efficiency with a controller that switches the pump off at low flow i.e. pressure controllers.

Many systems suffer small leaks and supplying the top-up water from a pressure tank will result in significant energy savings. Over its lifetime, a pressure tank will pay for itself many times.

Technical Data and Installation

Max working pressure 10 bar (147psi)

Maximum pre-charge 5.5 bar (81 psi)

Max operating Temperature 90 deg C

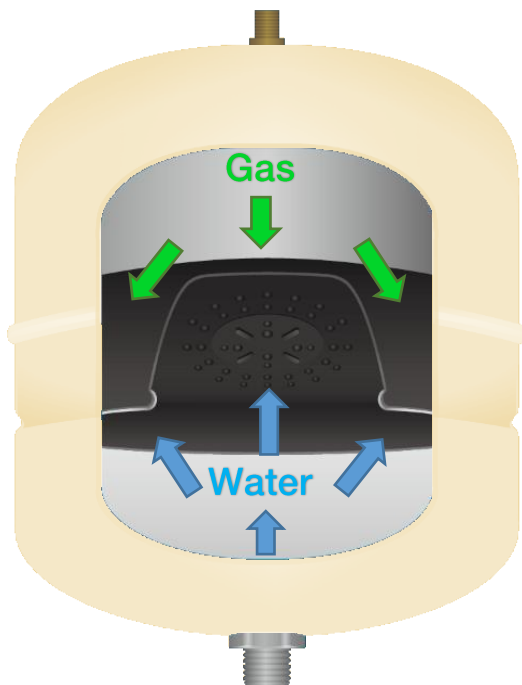

4 bar nitrogen pre-charge

Triple Layer paint

Cold rolled carbon steel

Butyl rubber diaphragm

Polypropylene liner

1" BSPT SS inlet 3, 8 and 18 L





Respect the maximum pressure settings at all times.

Failure to follow instructions can cause a rupture or an explosion causing serious or fatal personal injury and/or property damage.



Dimensions

P/N	Model	Size: Dia x Total Height	Outlet	Footing
Vertical				
811169	BPT-3	Φ140 x 220	1" BSPT (M)	 None
811170	BPT-8	Φ203 x 304		
811171	BPT-18	Φ280 x 364		
811172	BPT-24	Φ290 x 415		
811870	BPT-40	Φ355 x 428		
Horizontal with Pump Mounting				
811180	BPT-24H	Φ290 x 326 x 415 long	1" BSPT (M)	
811181	BPT-60H	Φ390 x 326 x 428 long		
Vertical Freestanding				
811173	BPT-60	Φ390 x 592	1" BSP Elbow (F)	 Plastic Ring Metal Ring
811174	BPT-80	Φ432 x 693		
811175	BPT-100	Φ430 x 765		
811176	BPT-160	Φ550 x 931		
811177	BPT-200	Φ550 x 1068	1 1/4" BSP Elbow (F)	
811178	BPT-300	Φ550 x 1463		
811179	BPT-450	Φ650 x 1410		

Setting Pre-charge



Failure to follow pre-charge instructions voids warranty

A pressure tank should NEVER accept more water than 1/3 of its total volume as it will stress the internal diaphragm leading to premature failure.

First check the tank pre-charge is within +/-10% of factory 4 bar setting.

Set pre-charge to the required setting with no water pressure present.

1. If in doubt, **set pre-charge to 66% of maximum system pressure.**
 - a. Electronic pressure controllers and variable speed drives should be set to 65% of maximum system pressure unless otherwise specified.
2. Pumps controlled by pressure switches with less than 2 bar (30 psi) between start and stop pressure can be set 0.1 bar (2 psi) below the start pressure
3. For pressure tanks installed on Mains pressure set pre-charge to match mains pressure
4. For thermal expansion or water-hammer control, set to 100% of system pressure

Pre-charge lookup chart

		CUT IN PRESSURE							
		1.5	2.0	2.5	3.0	3.5	4.0	4.5	5.0
CUT OUT PRESSURE	2.5	1.30	1.80	Green cells - precharge is 20kpa below cut in pressure					
	3.0	1.66	1.80	2.30	Blue cells - precharge is 66.6% of cut out pressure				
	3.5	2	1.80	2.30	2.80				
	4.0	2.33	2.33	2.33	2.80	3.30			
	4.5	2.66	2.66	2.66	2.80	3.30	3.80		
	5.0	3	3	3	2.80	3.30	3.80	4.30	
	5.5	3.33	3.33	3.33	3.33	3.30	3.80	4.30	4.80
	6.0			3.66	3.66	3.66	3.80	4.30	4.80
	6.5			4	4	4	4	4.30	4.80
	7.0			4.33	4.33	4.33	4.33	4.33	4.80
	8.0			4.99	4.99	4.99	4.99	4.99	4.99
	9.0					5.66	5.66	5.66	5.66

Pre-charge pressure greater than 5 bar

Where the system pressure requires pre charge pressure greater than 5 bar the following procedure must be followed to prevent damage to the diaphragm

1. Set the gas pre-charge of the tank to 5 bar
2. Install the tank into the system.
3. Fill the system with water to equalise both system and pre-charge pressure at 5 bar
4. Add additional gas pre-charge pressure towards the desired total in steps not exceeding 3 bar per step
5. Should the maximum 3 bar (per step) gas pressure be reached, add additional system water to equalise both system and pre-charge pressures .
6. Repeat steps 3 to 5 until the desired pre-charge is reached.

Emptying a tank that has a pre-charge over 5 bar,

1. Ensure there is some water in the tank.
2. Isolate the tank from the system (close isolation valve) ensuring no additional water can get into the tank (shut off the pump and / or any water supply).
3. Release air from tank until 3 bar (44 psi) tank / air pressure is remaining.
4. Open a drain valve and afterwards the isolation valve to drain the tank.



CAUTION: Make sure that the system pressure is never lower than 5 bar below pre-charge. If system pressure needs to be lowered, the tank should be isolated or emptied as previously described

Tank sizing – Variable Frequency Drives

Typically, 18 – 25 litre pressure tanks, or 80 – 100 litre pressure tanks are used on pumps and pump-sets controlled by variable frequency drives operating at constant pressure.

Every situation is unique and there are many circumstances, due to the hydraulic nature of the installation, where a greater drawdown volume is required.

In cases where the system can rapidly change to full flow, the variable frequency drive will have a minimum response time. Typically, this time is approx. 10 seconds for a single pump 1 and then 12 seconds for each subsequent pump.

Assuming the connected pipework can handle the sudden change in velocity, a larger pressure tank (or tanks) may be necessary to buffer the response time.

In this case the pressure tank drawdown and therefore minimum sizing should be calculated using Boyles law

$$V = \frac{(P_{pc}+100) \times C}{P_{ci}+100} - \frac{(P_{pc}+100) \times C}{P_{co}+100}$$

- V = draw off required to cover pump response time
- P_{pc} = the pressure tank charge pressure in kPa
66% of P_{co} value or greater
- P_{ci} = the nominated Wake Up pressure in kPa
- P_{co} = the Setpoint in kPa

Installation

Install the tank as close to the pump and controller as practical

The BIANCO NXT PRO and PRO PLUS controllers have a removable accumulator exposing a 1" BSPF thread. After removing the accumulator, a flexible hose can be plumbed from the controller to the pressure tank.



A 3, 8 or 18 litre tank can be screwed directly into the rear or the controller as long as the weight of the tank is supported.

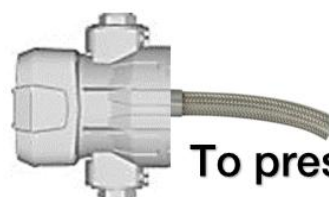
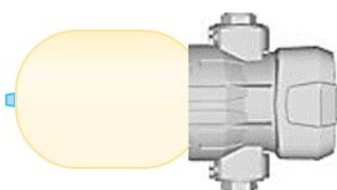

Installation con't

Yearly pre-charge checks are recommended for best results. If there is a drop in the pre-charge pressure from installation, replace the pressure tank.

In-line pressure tanks without a footing require a support bracket fitted

Installing isolation valves and a drain valve will make it easy to check pre-charge pressure

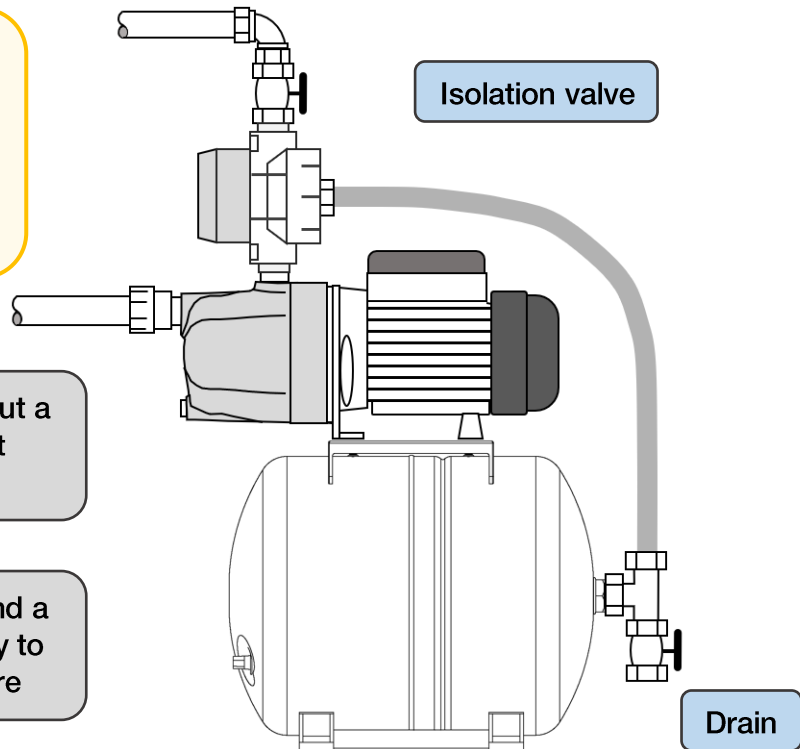

For best results, locate the pump and pressure tank close together

The pressure switch can be installed on the pump or on the pressure tank

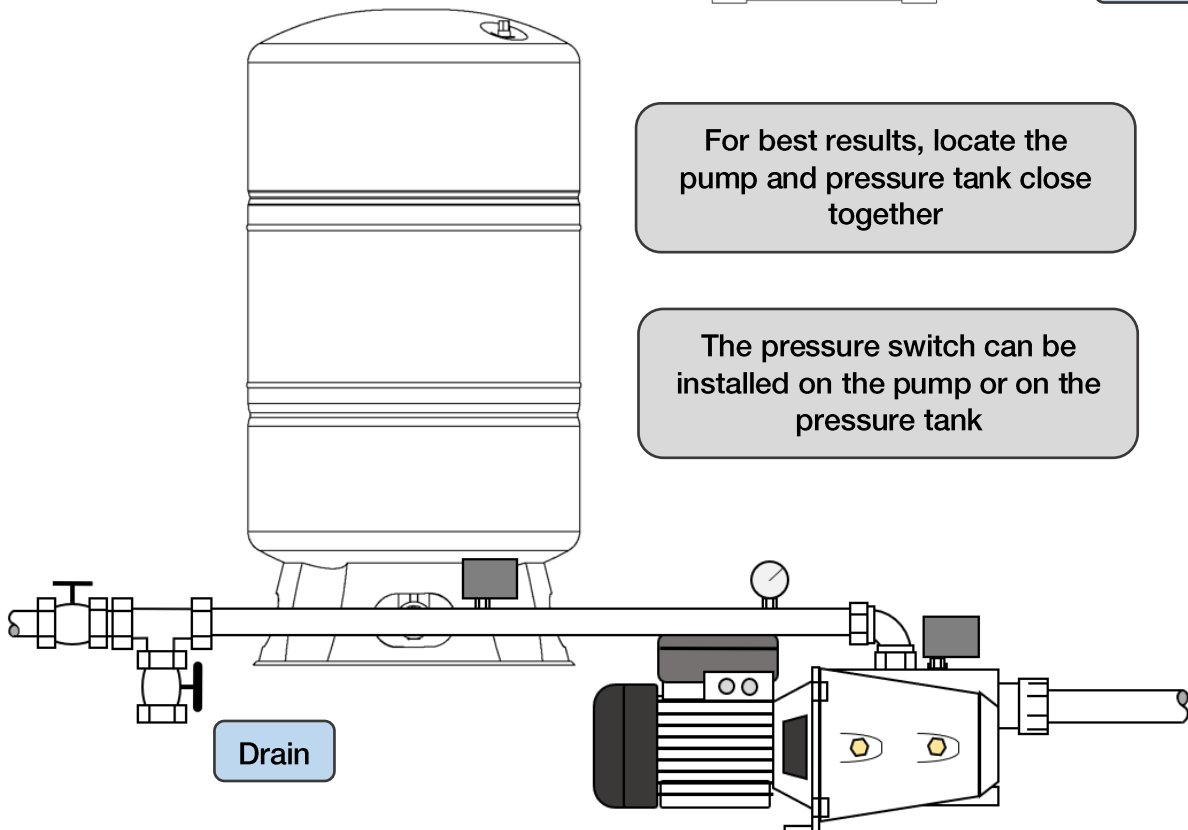

If there is a noticeable lag in water delivery, adjust the cut-in pressure upwards reducing the differential. Adjusting the cut in pressure does not require the tank pre-charge to be altered.

Warranties – Terms and Conditions

This warranty is given in addition to the consumer guarantees found within the Australian Competition and Consumer Act 2010 (Cth) for goods purchased in Australia and the Consumer Guarantees Act 1993 NZ for goods purchased in New Zealand:



1) White International Pty Ltd / White International NZ Ltd (White International) warrant that all products distributed are free from defects in workmanship and materials, for their provided warranty period as indicated on the top or opposite side of this document. Subject to the conditions of the warranty, White International will repair any defective products free of charge at the premises of our authorised service agents throughout Australia and New Zealand if a defect in the product appears during the warranty period. If you believe that you have purchased a defective product and wish to make a claim under this warranty, contact us on our Sales Hotline on 1300 783 601, or send your claim to our postal address or fax line below and we will advise you as to how next to proceed. You will be required to supply a copy of your proof of purchase to make a claim under this warranty.

2) This warranty excludes transportation costs to and from White International or its appointed service agents and excludes defects due to non-compliance with installation instructions, neglect or misuse, inadequate protection against the elements, low voltage or use or operation for purposes other than those for which they were designed. For further information regarding the suitability of your intended application contact us on our Sales Hotline on 1300 783 601. If you make an invalid claim under this warranty, the original product will be sent back to you unrepai red.

3) This warranty refers only to products sold after the 1st January 2012, and is not transferable to another product type and only applies to the original owner, purchaser or end user, and is in addition to the consumer guarantees found within the Competition and Consumer Act 2010 (Cth) for goods purchased in Australia and the Consumer Guarantees Act 1993 (NZ) for goods purchased in New Zealand.

4) Our goods come with guarantees that cannot be excluded under the Australian Consumer Law. You are entitled to a replacement or refund for a major failure and for compensation for any other reasonably foreseeable loss or damage. You are also entitled to have the goods repaired or replaced if the goods fail to be of acceptable quality and the failure does not amount to a major failure. 2 YEAR WARRANTY.

5) To the fullest extent permitted by law, White International excludes its liability for all other conditions or warranties which would or might otherwise be implied at law. To the fullest extent permitted by law, White International's liability under this warranty and any other conditions, guarantees or warranties at law that cannot be excluded, including those in the Competition and Consumer Act 2010 (Cth), is expressly limited to: (a) in the case of products, the replacement of the product or the supply of equivalent product, the payment of the cost of replacing the product or of acquiring an equivalent product or the repair of the product or payment of the cost of having the product repaired, is at the discretion of White International or a 3rd party tribunal elected under the Competition and Consumer Act 2010 (Cth) for goods purchased in Australia and the Consumer Guarantees Act 1993 (NZ) for goods purchased in New Zealand; and







6) To the fullest extent permitted by law, this warranty supersedes all other warranties attached to the product or its packaging.

7) In the case of services, supplying the services again or the payment of the cost of having the services supplied again, is at the discretion of White International or a 3rd party tribunal elected under the Competition and Consumer Act 2010 (Cth) for goods purchased in Australia and the Consumer Guarantees Act 1993 (NZ) for goods purchased in New Zealand. 8) Our warranty commences from the date of purchase of the above-mentioned pumps. Proof of purchase is required before consideration under warranty is given.

Record your date of purchase in the space below and retain this copy for your records.

Date of Purchase**Model Purchased**

Warnings

	This tank is intended for use in potable water systems only and any other use may be dangerous voiding the warranty. Aggressive water conditions can impact on the product life expectancy.
	Respect the maximum pressure settings at all times. Failure to follow instructions can cause a rupture or explosion possibly causing serious or fatal personal injury and/or property damage.
	The pressure tank and associated fittings must be installed with respect to all local regulations and guidelines.
	This pressure tank is not intended for use by persons (including children) with reduced physical, sensory or mental capabilities, or lack of experience and knowledge, unless they have been given supervision or instruction concerning use of the appliance by a person responsible for their safety. Children should be supervised to ensure that they do not play or tamper with the pressure tank.
	A pressure tank with insufficient pre-charge pressure can stress the internal diaphragm leading to premature failure. For best results, a yearly pre-charge pressure check is recommended.
	Replace the tank if there is any sign of external corrosion.



www.whiteint.com.au

www.whiteint.co.nz

Please always refer to our website for further technical information & new product innovations

Disclaimer: Every effort has been made to publish the correct information in this manual. No responsibility will be taken for errors, omissions or changes in product specifications.

© 2025 Copyright White International Pty Ltd

TM ® - WARNING: Please be aware that various brands & products depicted within this document are subject to trademark, patent or design registrations. Infringement of any intellectual property contained within this document without express written authority by the appropriate intellectual property holder may result in further legal action to be taken. For any queries regarding use of the contained information please feel free to contact White International Pty Ltd.