

# esyBOX

ELECTRONIC PRESSURISATION SYSTEM





## PERFORMANCE RANGE

The performance curves are based on kinematic viscosity values = 1 mm<sup>2</sup>/s and density equivalent to 1000 kg/m<sup>3</sup>. Curve tolerance according to ISO 9906.

### GRAPHIC SELECTION TABLE

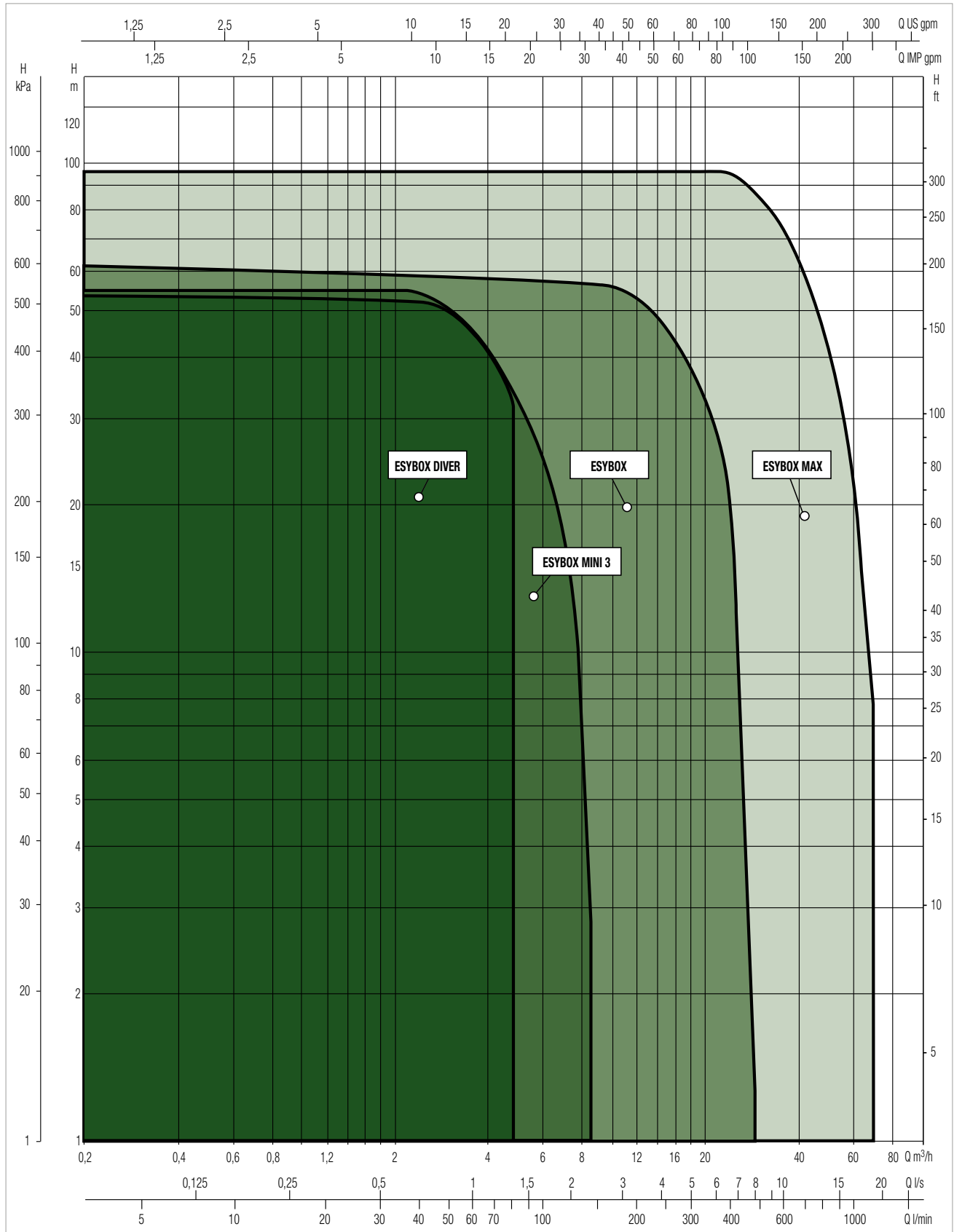

**+11%**  
Energy savings

**BUILT-IN  
CONNECTIVITY**

Remote management with  
web portal and DConnect App



### TECHNICAL DATA

**Flow rate:** Up to a 7,2 m<sup>3</sup>/h

**Head:** 65 m

**Type of pumped liquid :** Clean, free from solid or abrasive substances, non-viscous, non-aggressive, non-crystallized and chemically neutral

**Liquid temperature :** +40°C

**Maximum ambient temperature:** +50°C

**Maximum suction depth:** 8 m

**Maximum operation pressure:** 8 bar / 800 kPa

**Motor protection class:** IP X4

**Motor insulation class:** F

**Impeller material:** Technopolymer

**Single phase power input:** 230 V 50 Hz

**Power cord (m) and plug:** 1,5 meters with power plug

**Type of installation:** Fixed, vertically, horizontally or on the wall with special accessories (supplied separately)

**Certification:** WRAS, ACS

Multi-impeller self-priming electronic system for pressurization, rainwater reuse, drawing ground water, gardening and irrigation and agriculture and irrigation in residential building service and commercial building service. Possibility to connect up to four ESYBOX together to create pressure units. Adjustable display. Integrated connectivity allows immediate access to cloud services, without any additional accessories. The remote control works thanks to the DConnect, for viewing and managing parameters, settings and comfort functions. The careful choice of materials and the water-cooled motor make the pump particularly quiet, just 43 dB, suitable for installation even in living areas. Can be positioned vertically, horizontally or on the wall with special accessories (supplied separately). With the same performance, consumption is even lower.

### CONSTRUCTION FEATURES OF THE PUMP

Self-priming multi-impeller pump. 2-liter expansion vessel incorporated. Protective hull in sound-absorbing ABS. Technopolymer impellers. Integrated flow and pressure sensors.

### CONSTRUCTION FEATURES OF THE MOTOR

Motor cooled by the pumped liquid, stainless steel motor jacket. Motor shaft in AISI 303 stainless steel.

### CONSTRUCTION FEATURES OF THE ELECTRONIC

Adjustable display. The variable frequency drive function saves energy and protects against water hammer. Integrated protections: protection from dry running, amperometric and anomalous voltages, overtemperature, frost, anti-blocking and anti-cycling. Construction according to CEI 2-3 / CEI 61-69 (EN 60335-2-41). Guided procedure for the first start-up, easy configuration, possibility to display the alarm history. Wireless connection.

### MATERIALS

N°	PARTS *	MATERIALS
1	MOTOR FLANGE	TECHNOPOLYMER
2	ROTOR SHAFT	AISI 303 STAINLESS STEEL
3	MOTOR JACKET	AISI 304 STAINLESS STEEL
5	OR GASKET	NBR
7	SINTERED PLATE	AISI 304 STAINLESS STEEL
11	1" PLUG	TECHNOPOLYMER
13	SUCTION BODY	TECHNOPOLYMER
14	1" INSERT	NICKLED BRASS
15	SHUTTER	TECHNOPOLYMER
17	SPRING	AISI 303 STAINLESS STEEL
20	DIFFUSER	TECHNOPOLYMER
21	DIFFUSER BODY	TECHNOPOLYMER
22	IMPELLER	TECHNOPOLYMER
22c	SHIM RING	AISI 316 STAINLESS STEEL
24	NUT	AISI 316 STAINLESS STEEL
25	DIFFUSER END PLUG	TECHNOPOLYMER
27	MECHANICAL SEAL	CARBON IMPREGNATED RESIN / SILICON CARBIDE / EPDM
28	PUMP BODY	TECHNOPOLYMER
30	DISCHARGE BODY	TECHNOPOLYMER
36	FLOW SWITCH BODY	TECHNOPOLYMER
41	PRESS. STABLE. IMPELLER	TECHNOPOLYMER
46	DISCHARGE MANIFOLD	TECHNOPOLYMER
47	1" 1/4 PLUG	TECHNOPOLYMER
52	NON-RETURN VALVE	TECHNOPOLYMER / RUBBER / STEEL
57	TANK	TECHNOPOLYMER / RUBBER
58/1	PRESSURE SENSOR BODY	TECHNOPOLYMER

\* In contact with liquid

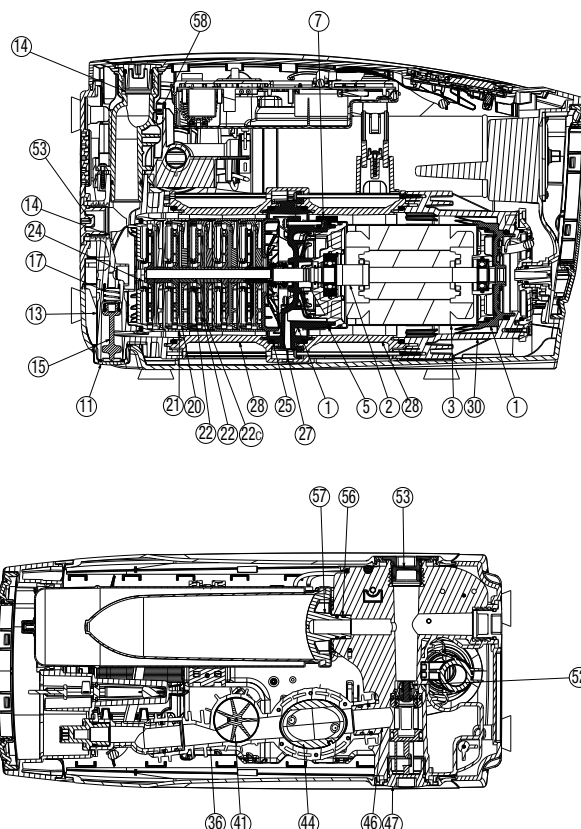

# ESYBOX - ELECTRONIC PRESSURISATION SYSTEM

Liquid temperature range: from 0°C to +35°C for domestic use - from 0°C to +40°C for other uses. - Maximum ambient temperature: +50°C

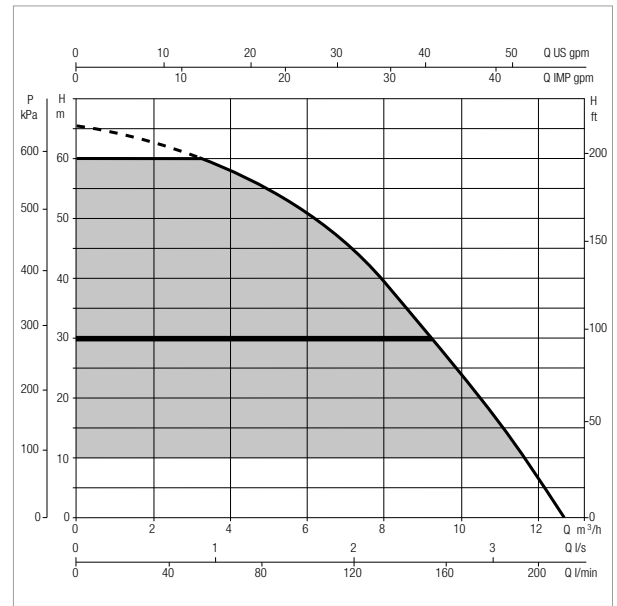
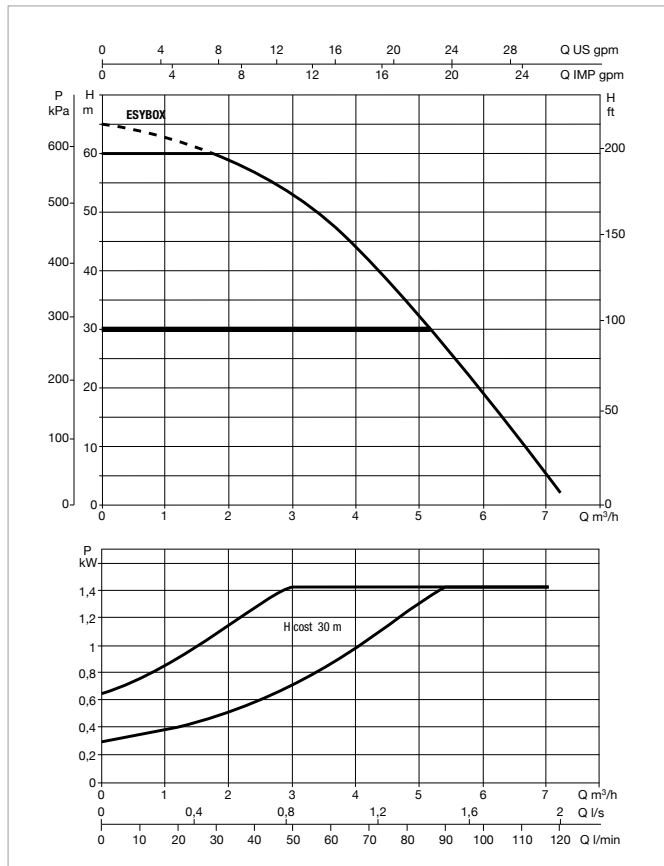

Performance refers to 2 assembled ESYBOX in ESYTWIN.  
Pressure losses included

The performance curves are based on the kinematic viscosity values = 1 mm²/s and density equivalent to 1000 kg/m³. Curve tolerance according to ISO 9906.

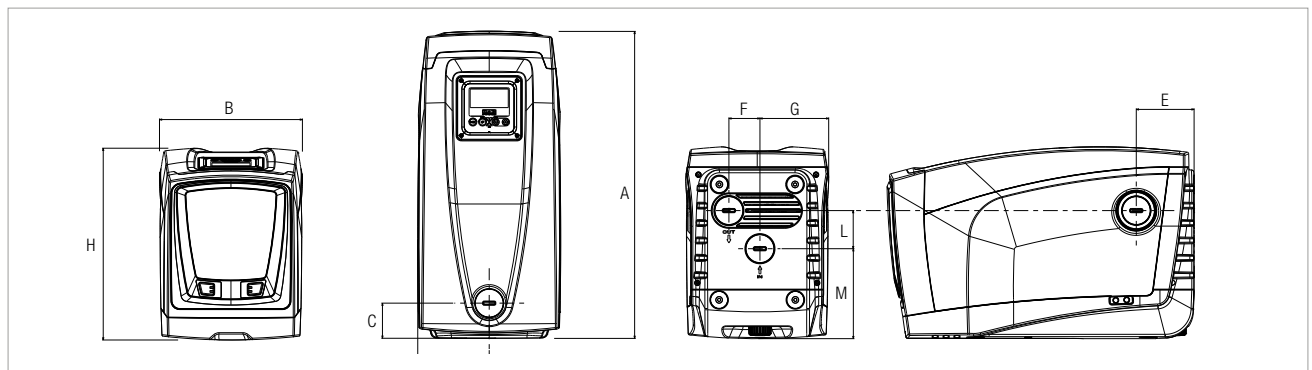

MODEL	Q=m³/h	0	0,6	1,2	1,8	2,4	3	3,6	4,2	4,8	5,4	6	6,6	7,2
		Q=l/min	0	10	20	30	40	50	60	70	80	90	100	110
ESYBOX	H (m)	65	63,5	61,5	59,5	57	53	48	41,5	35	27,5	19	10	2

MODEL	ELECTRICAL DATA				
	N° IMPELLER	POWER SUPPLY 50/60 Hz	P1 MAX		In A
			kW	HP	
ESYBOX	5	1 x 220 - 240V ~	1,4	1,9	10
ESYBOX - KIWA	5	1x220-240V ~	1,4	1,9	10

MODEL	A	B	C	D	E	F	G	I Ø	H	L	M	DNA	DNM	PACKING DIMENSIONS			GROSS Kg
	L/A	L/B	H														
ESYBOX	564	263	65	131,5	106	57	126,2	9	362	70	165,2	1"	1"	685	360	490	27
ESYBOX - KIWA	564	263	65	131,5	106	57	126,2	9	362	70	165,2	1"	1"	685	360	490	27

# DCONNECT DIGITAL SERVICES

## REMOTE CONTROL FOR ELECTRONIC RESIDENTIAL AND COMMERCIAL SYSTEMS

The DConnect service offers simple and intuitive remote control of your installation, without the need of a server or specialist personnel.

**With DConnect, you can remotely manage your installations as if you were right in front of them.**

Thanks to the system operation charts, you will also be able to optimise operation. You will also receive prompt notifications of any system faults.

### DCONNECT WEB PORTAL:

**Complete supervision, from your office**

Web portal that centralizes all systems and provides advanced and high value features: monitoring and control, data analysis, performances optimization. Optimized for larger screens allows you to monitor and control remotely your systems.

### DCONNECT ALLOWS YOU TO:

#### EASILY MONITOR YOUR SYSTEMS

The installations with green status are OK, while the orange ones need attention, and the red ones are experiencing problems.

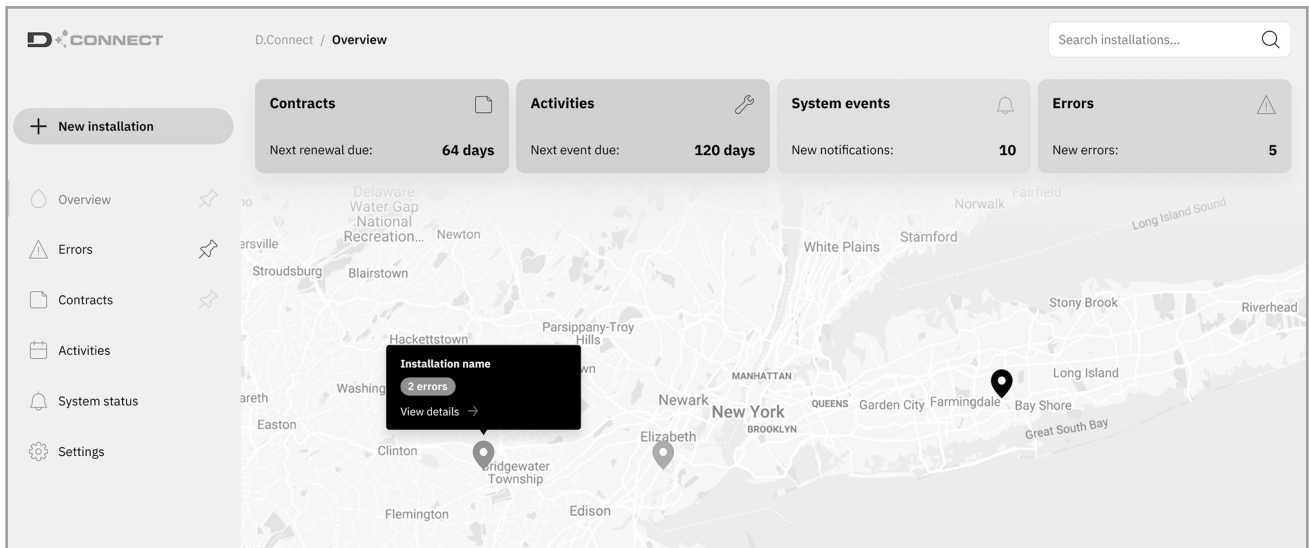

### TAKE ANY NECESSARY ACTIONS AS IF YOU WERE RIGHT IN THE PUMP ROOM

Using the internet site or the APPs, you will be able to easily and quickly control your systems.

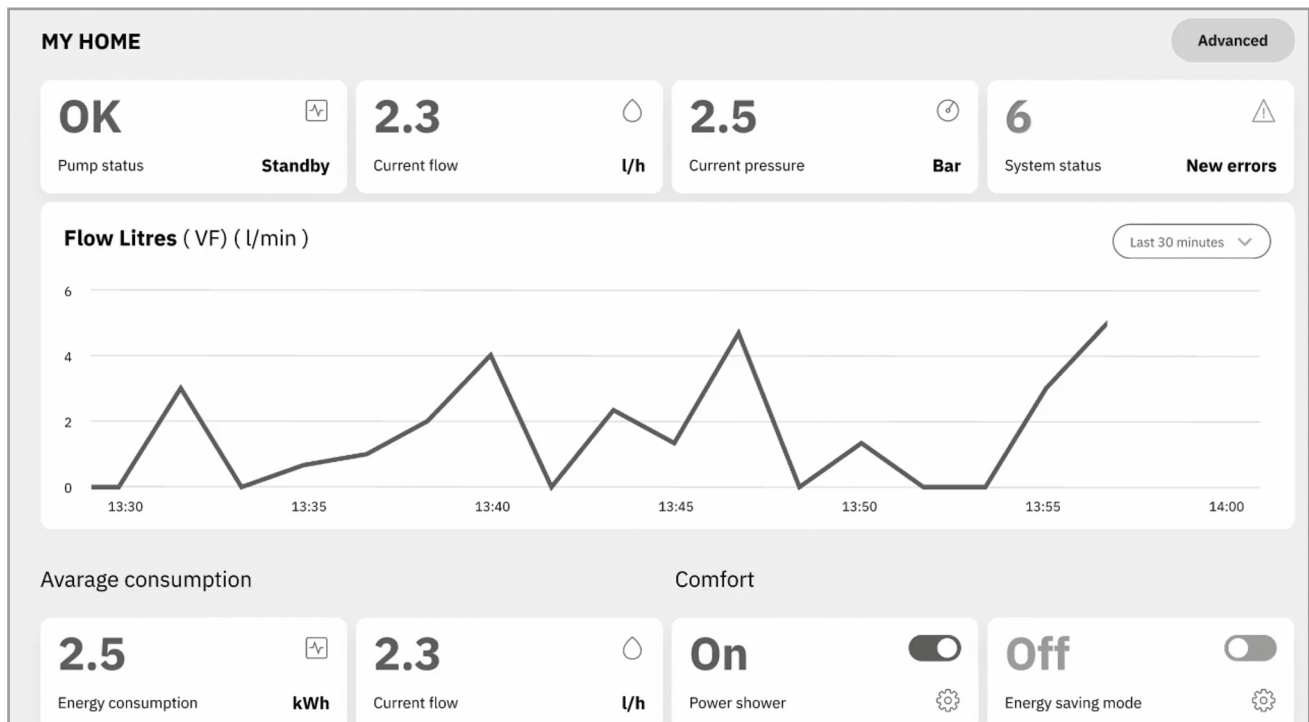

### REMOTE ALARMS

In case of alarm, the DConnect service will promptly send you a notification, so that you can check what is happening and organise a visit to the system before the issue becomes an emergency for your customer.

# DCONNECT DIGITAL SERVICES

## REMOTE CONTROL FOR ELECTRONIC RESIDENTIAL AND COMMERCIAL SYSTEMS

In order to use the DConnect service, registration and connected products are required.

Connect to the website: <https://dconnect.dabpumps.com> using Internet Browsers such as Microsoft Edge or Google Chrome.

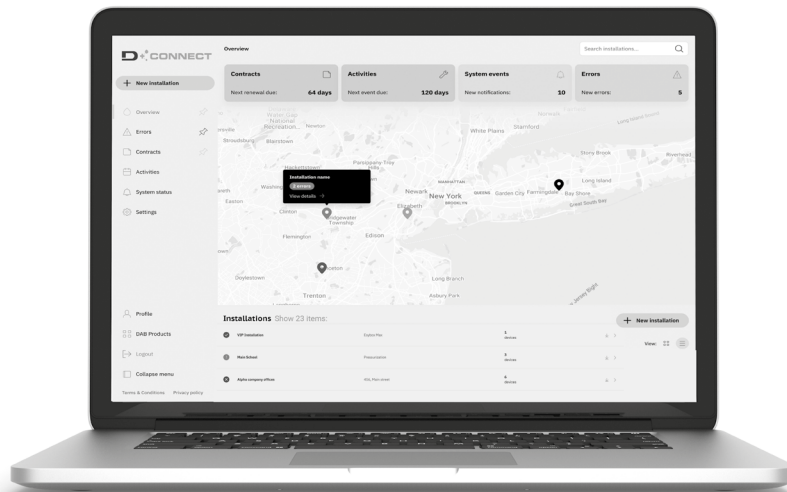

### DCONNECT

#### A WORK TOOL AT YOUR FINGERTIPS

Mobile app for devices local setup, remote supervision, device monitoring, configuration for all your systems and parameters tuning. You can be informed on your installation status and perform maintenance whenever you are.

All the power and flexibility of the DConnect web portal in your pocket.

The Android and iOS DConnect APPs can be downloaded from the relevant Stores:



### APP DAB LIVE!

Available for EsyBox Mini<sup>3</sup>



It makes easier for end users to supervise domestic systems in order to optimize consumption and maximize comfort, also thanks to Power Shower and Sleep Mode functions.

### WHAT PRODUCTS CAN YOU MANAGE USING THE DCONNECT SERVICE?

NgDrive, NgPanel, MCE/P, MCE/C, ADAC, Active Driver Plus, Ebox, Evoplus, EsyBox (old version), EsyBox Mini<sup>3</sup>, EsyBox Diver, Dtron 3, EsyBox Max.

For more information visit: [www.internetofpumps.com](http://www.internetofpumps.com)

## DCONNECT DIGITAL SERVICES

#### DATA RETENTION 1 MONTH MONITORING AND CONTROL

**BASIC PACKAGE**

**1 YEAR SERVICE**

#### DATA RETENTION 12 MONTH MONITORING AND CONTROL

**PLUS 12 PACKAGE**

**1 YEAR SERVICE**

**PLUS 36 PACKAGE**



**3 YEARS SERVICE**

2 trial months included Possibility to upgrade to a higher package at any time.

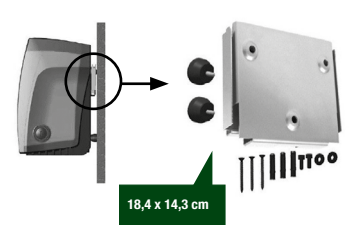

KIT OUTDOOR	DESCRIPTION
	<h3>ESYCOVER + ESYGRID</h3> <p><b>KIT OUTDOOR ESYBOX</b> Consisting of EsyCover + EsyGrid, which allows the installation of EsyBox outside, protecting it from rain and the entry of foreign bodies. <b>Vertical installation only.</b></p>

	DESCRIPTION
	<h3>KIT PIPE UNION 3PCS MF 1" WITH O-RING</h3> <p>Kit consisting of 2 x 3-piece unions, to facilitate the connection of EsyBox and EsyBox Mini<sup>3</sup> to the system.</p>
 <p>18,4 x 14,3 cm</p>	<h3>ESYWALL</h3> <p>Kit complete with brackets, screws, dowels and two accessories for absorption of vibrations.</p>

	DESCRIPTION
 <p>18 x 29 x 32 cm</p>	<h3>ESYDOCK</h3> <p>Thanks to the 4 plumbing configuration possibilities offers an 'installation even more rapid, easy and flexible. It is complete with all the interfaces required for connecting to the system. It incorporates anti vibration feet to ensure the same quietness as EsyBox.</p>
 <p>23 x 75 x 35 cm</p>	<h3>ESYTWIN</h3> <p>EsyTwin is the evolution of EsyDock, of which maintains all the benefits, for the creation of two groups of pumps. EsyTwin offers exceptional performance thanks to possibility of combined operation with a reduced size of 50% compared to any other equivalent traditional system.</p>
	<h3>ESYTWIN DOUBLE CONNECTION KIT</h3> <p>2" T suction and delivery manifold connection kit for the connection of 2 EsyTwin and the creation of boosters with up to 4 EsyBox. Suction and delivery manifold, each one consisting of: no. 2 x 1"1/4 Nipples no. 2 x 1"1/4 Female -and 2" male reductions no. 3 x 2" 3-Piece connectors no. 1 x 2" Female T connector</p>



# ACCESSORIES

ESYBOX





**DELIVERY AND SUCTION  
FITTING 1" 1/4**





**68 x 29 x 35 cm**



**KIT DIMENSIONS  
73 x 75 x 35 cm**

	DESCRIPTION
 <p>*EsyBox not supplied with EsyTank</p> <p><b>166 x 87 x 60 cm</b></p>	<h2>ESYTANK</h2> <p>Tank specially studied to better integrate with EsyBox and equipped with:</p> <ul style="list-style-type: none"> <li>• EsyDock (specially versioned) for quick connection.</li> <li>• Suction hose with foot valve</li> <li>• Filling valve from the water supply with float</li> <li>• Overflow</li> <li>• Flow connection</li> <li>• Preparation for ground mounting</li> <li>• Inspection plug</li> </ul> <p>Capacity 500 L with the possibility of expansion on 3 sides.</p>
 <p>*EsyBox not supplied with EsyTank</p> <p><b>115 x 81 x 57 cm</b></p>	<h2>ESYTANK 300</h2> <p>Tank specially studied to better integrate with EsyBox.</p> <ul style="list-style-type: none"> <li>• Esydock (specially versioned) for quick connection.</li> <li>• Suction hose with foot valve</li> <li>• Filling valve from the water supply with float</li> <li>• Overflow</li> <li>• Flow connection</li> <li>• Preparation for ground mounting</li> <li>• Inspection plug</li> </ul> <p>Capacity 300 L</p>
	<h2>ESYTANK AUXILIARY CISTERN</h2> <p>The EsyTank auxiliary cistern is supplied without any fittings or the EsyDock. The tank has a modular design to couple easily with other EsyTank units, making the system expandable to the necessary capacity. It can be connected on three sides (at side and rear) using the EsyTank TANK COUPLING KIT.</p>

	DESCRIPTION
	<p><b>ESYTANK COUPLING KIT</b></p> <p>The EsyTank coupling kit is composed of a PVC sleeve with gasket (D.160 mm L=150), two PVC aligning pipes (D.50mm x L=60) and a connecting ring nut for a 2-pump option. It allows the connection of several EsyTank units or between EsyTank and EsyTank auxiliary cistern.</p>
	<p><b>ESYTANK OPTIONAL DELIVERY KIT</b></p> <p>Composed of a 1" PP pipe. It allows an auxiliary delivery for single tank systems or with the COUPLING KIT it allows several EsyTank and EsyBox systems to be linked together and to create pressure boosting units with several pumps and tanks.</p>



# DNA<sup>®</sup>

PUMPS SELECTOR



## On-line selection tool



**DAB PUMPS LTD.**

Unit 6 Gilbert Court  
Newcomen Way, Severalls Park  
CO4 9WN  
Colchester  
ordersuk@dwtgroup.com  
Tel. +44 0333 777 5010



**DAB PUMPS IBERICA S.L.**

Calle Verano 18-20-22  
28850 - Torrejón de Ardoz - Madrid  
Spain  
Info.spain@dwtgroup.com  
Tel. +34 91 6569545



**DAB PUMPS (QINGDAO) CO. LTD.**

No.10 Xindong Road  
Jiulong Town,  
Jiaozhou City  
266319 Qingdao (Shandong) - China  
sales.cn@dwtgroup.com  
Tel. +86 400 186 8280



**DAB PUMPS BV**

'tHofveld 6 C1  
1702 Groot Bijgaarden - Belgium  
info.belgium@dwtgroup.com  
Tel. +32 2 4668353



**DAB PUMPS HUNGARY KFT.**

H-8800  
Nagykanizsa, Buda Ernő u.5  
Hungary  
Tel. +36 93501700



**DAB PUMPS DE MÉXICO, S.A. DE C.V.**

Av Amsterdam 101 Local 4  
Col. Hipódromo Condesa,  
Del. Cuauhtémoc CP 06170  
Ciudad de México  
Tel. +52 55 6719 0493



**DAB PUMPS B.V.**

Statenlaan, 4  
5223 LA, 's-Hertogenbosch  
Nederland  
info.nl@dabpumps.com  
Tel. +31 416 387280



**DAB PUMPS POLAND Sp. z o.o.**

Ul. Janka Muzykanta 60  
02188 Warszawa - Poland  
sprzedaz@dabpumps.com.pl



**DAB PUMPS OCEANIA PTY LTD**

426 South Gippsland Highway,  
Dandenong South VIC 3175 - Australia  
info.oceania@dwtgroup.com  
Tel. +61 1300 378 677



**DAB PUMPS GMBH**

Am Nordpark 3  
D - 41069 Mönchengladbach - Germany  
info.germany@dwtgroup.com  
Tel. +49 2161 47388-0  
Fax +49 2161 47388-36



**DAB PUMPS SOUTH AFRICA (PTY) LTD**

Twenty One industrial Estate,  
16 Purlin Street, Unit B, Warehouse 4  
Olifantsfontein - 1667 - South Africa  
info.sa@dwtgroup.com  
Tel. +27 12 361 3997



**PT DAB PUMPS INDONESIA**

Satrio Tower lantai 26  
unit C-D, Jl. Prof. Dr. Satrio Kav. C4,  
Kel. Kuningan Timur, Kec. Setiabudi, Kota Adm.  
Jakarta Selatan, Prov. DKI Jakarta. - Indonesia  
Tel. +62 2129222850